

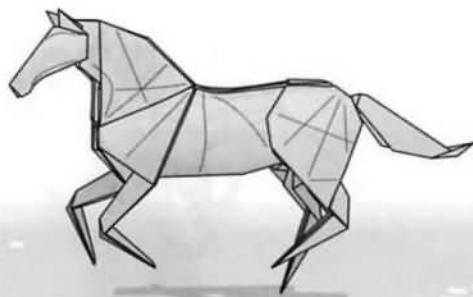

LIHAHA

# 馬

作/図 小松英夫



"HORSE"

model designed by Komatsu Hideo May 1999  
diagrams produced by K.H. Nov. 1999 - Jan. 2000



1

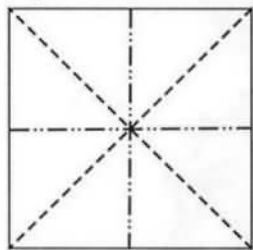

折り筋をつける

2

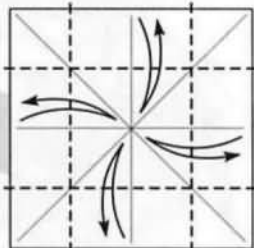

折り筋をつける

3

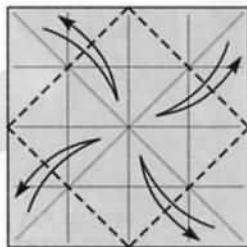

折り筋をつける

4

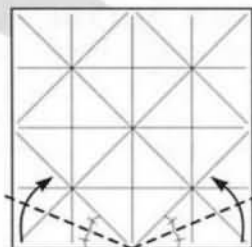

線を折り筋に合わせて折る

7

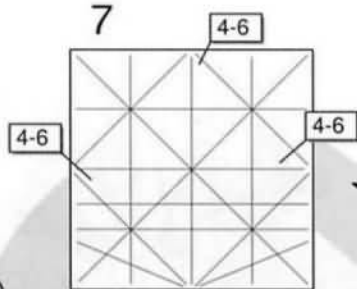

他の3つの辺について  
4~6と同様に  
折り筋をつける

6

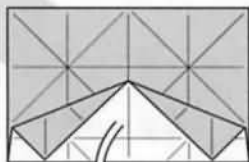

折り筋をつけたら  
すべて広げる

5

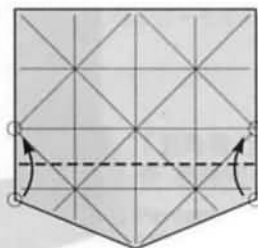

カドと折り筋を  
合わせて折る

8

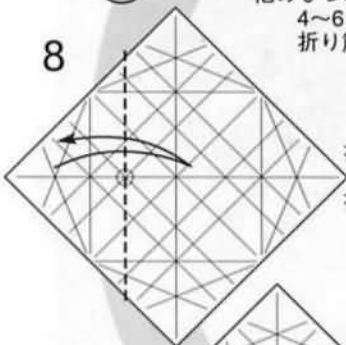

折り筋の交点を  
通る線で  
折り筋をつける

9

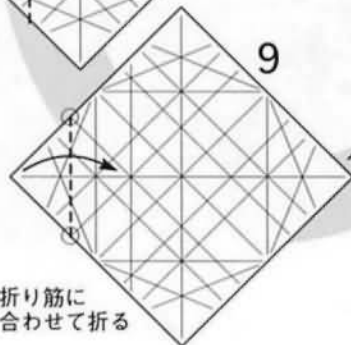

折り筋に  
合わせて折る

10

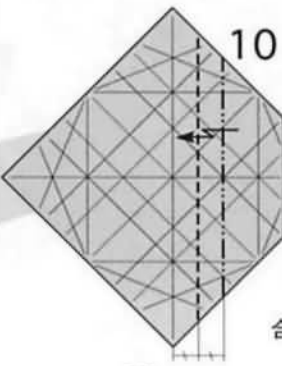

山折りの  
折り目をつまんで  
中心線に  
合わせて折る

11

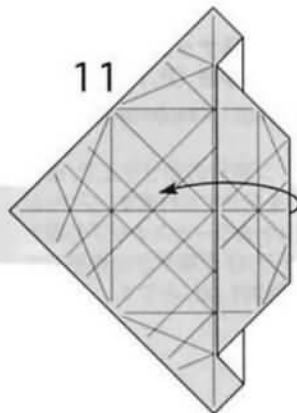

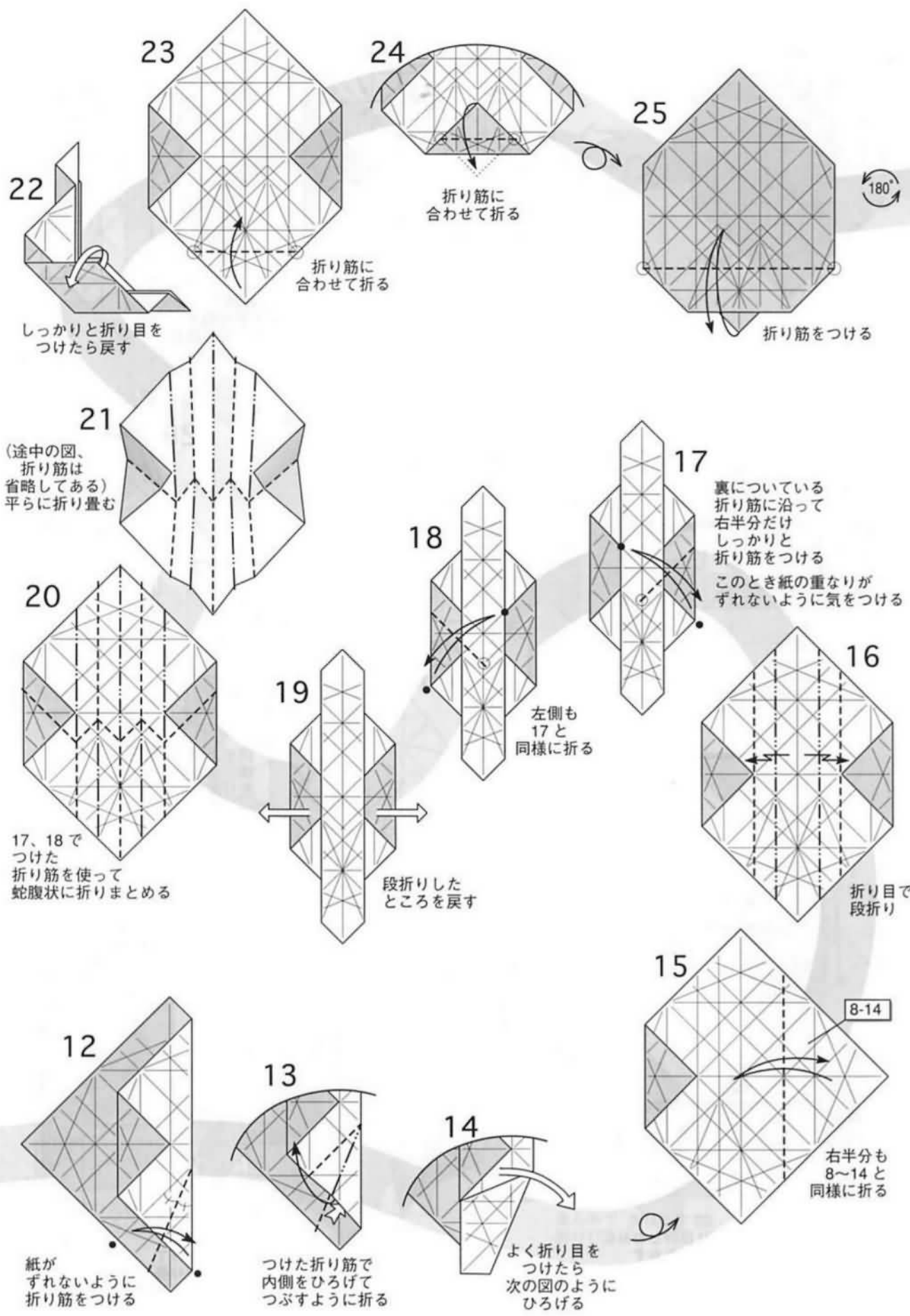

23

24

25

22

21

17

18

20

19

16

12

13

14

15

8-14

しっかりと折り目をつけたら戻す

折り筋に合わせて折る

折り筋に合わせて折る

折り筋をつける

(途中の図、折り筋は省略してある) 平らに折り畳む

裏についている折り筋に沿って右半分だけしっかりと折り筋をつける  
このとき紙の重なりがずれないように気をつける

左側も17と同様に折る

17、18でつけた折り筋を使って蛇腹状に折りまとめる

段折りしたところに戻す

折り目で段折り

紙がずれないように折り筋をつける

つけた折り筋で内側をひろげてつぶすように折る

よく折り目をつけたら次の図のようにひろげる

右半分も8~14と同様に折る

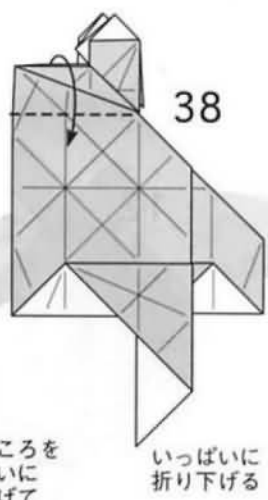
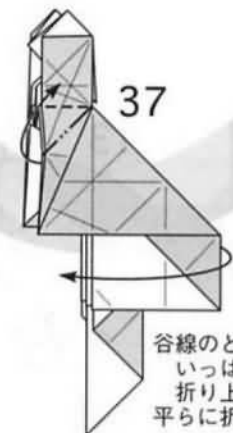
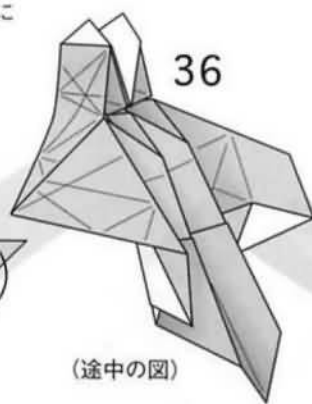
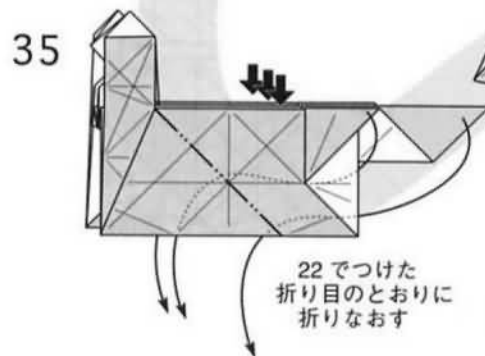
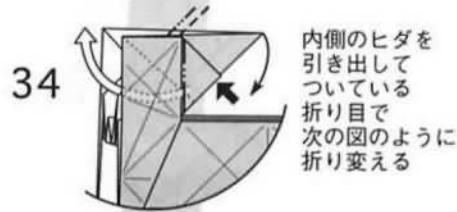
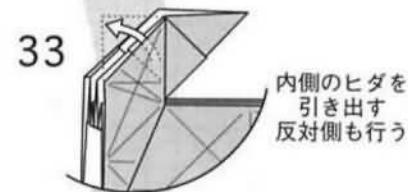
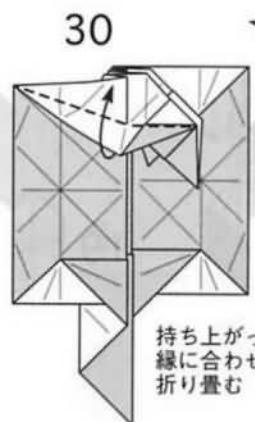
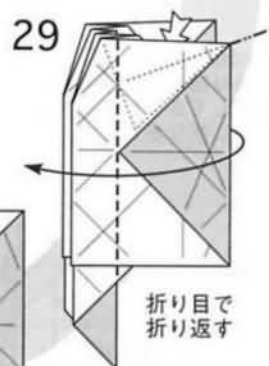
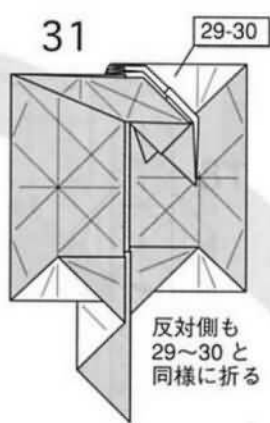
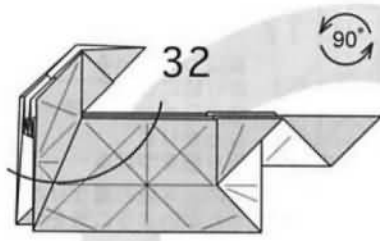
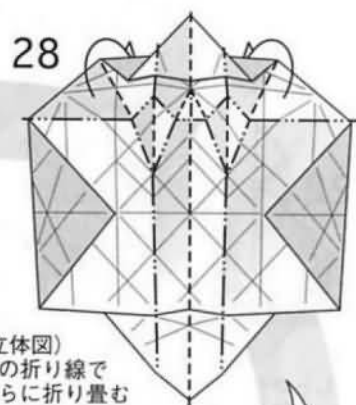
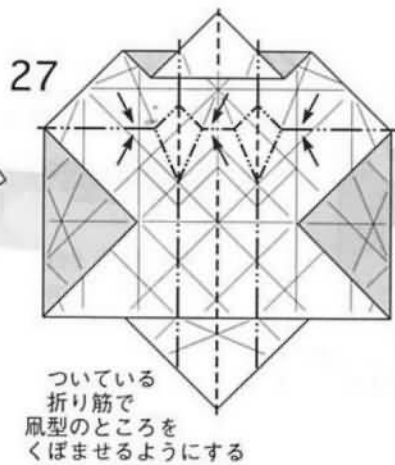
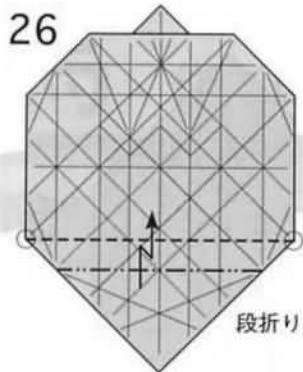

48

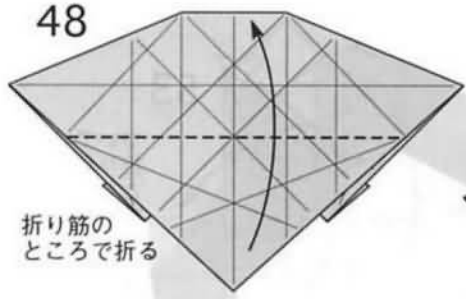

折り筋の  
ところで折る

49

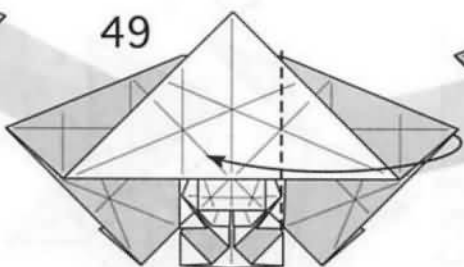

折り筋に沿って  
カドを折り返す

50

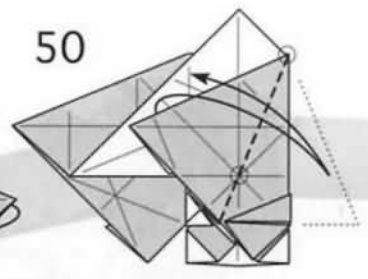

折り目をつける

47

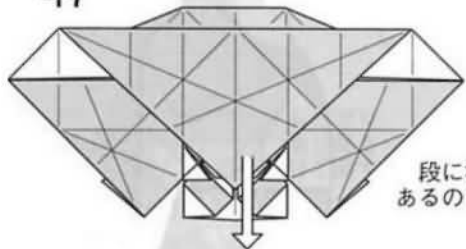

段に折って  
あるのをひらく

46

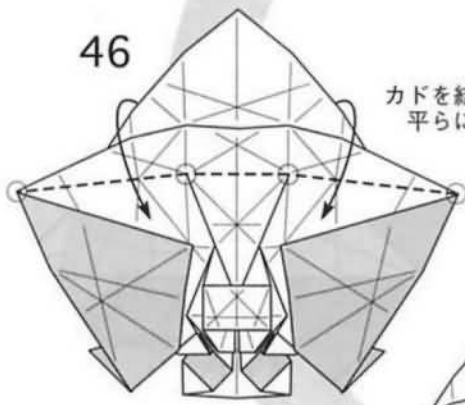

カドを結ぶ線で  
平らに折る

44

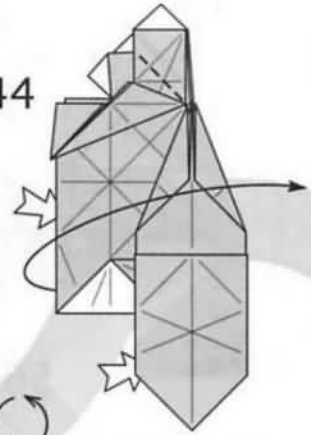

次の図のように  
内側を大きくひらく

1. 折り目を  
付けて戻す

2. 向こう  
側へ折る

43

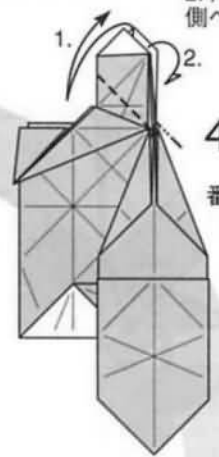

番号順に  
折る

45

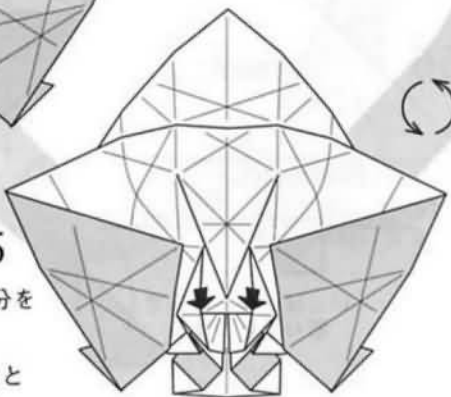

持ち上がった部分を  
次の図のように  
平らにつぶす  
(あまりしっかりと  
折らなくてよい)

42

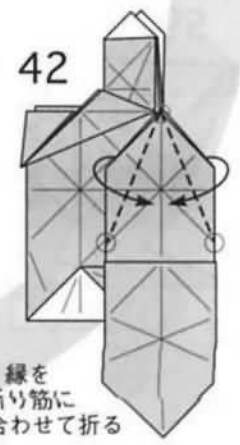

線を  
折り筋に  
合わせて折る

39

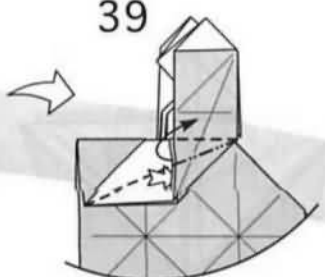

内側をひろげて  
ずらすように折る

40

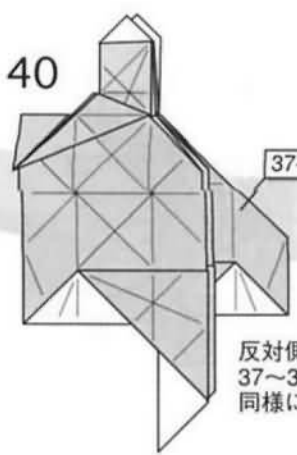

反対側も  
37~39と  
同様に折る

41

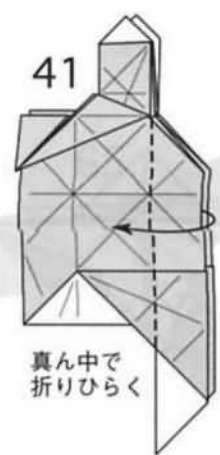

真ん中で  
折りひらく

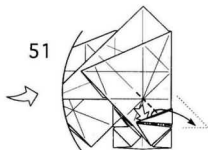

51

カドをつまむように折る

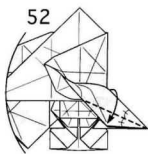

52

線に合わせて折る

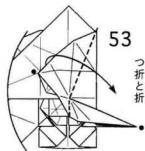

53

ついている  
折り目の  
とおりに  
折り畳む

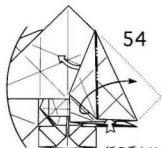

54

紙の重なりを  
外してずらす

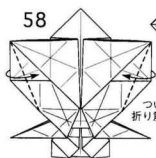

58

ついている  
折り筋で折る

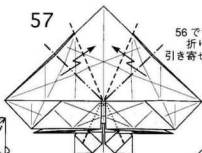

57

56でつけた  
折り目で  
引き寄せて折る

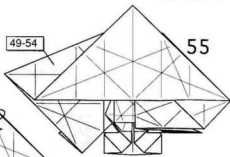

49-54

55

左側も49~54と  
同様に折る

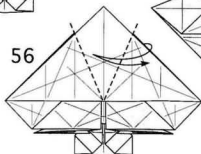

56

いっぱいのところ  
折り目をつける

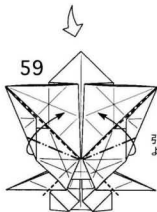

59

引き寄せる  
ように折る

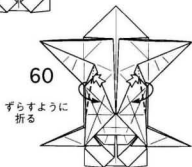

60

ずらすように  
折る

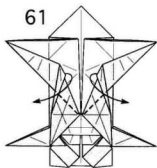

61

軽く折り返す

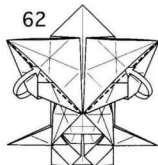

62

ヒダの下に  
折って差し込む



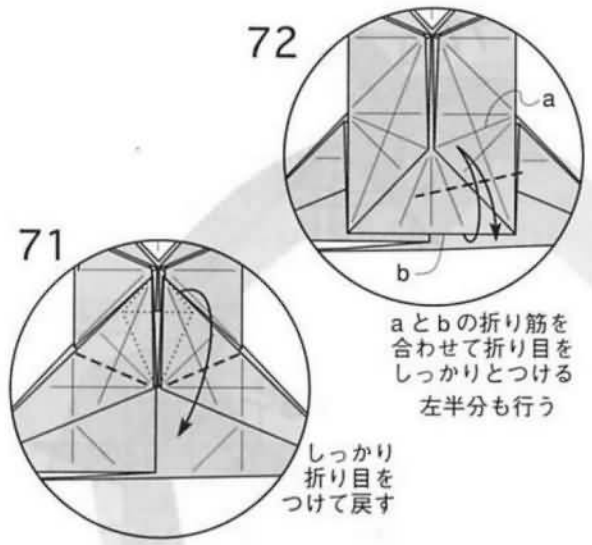

72

71

74

73

aとbの折り筋を  
合わせて折り目を  
しっかりとつける  
左半分も行う

しっかり  
折り目をつけて戻す

図をよく見て  
折り目をつける

70のとおり折る

70

左右に  
引き寄せるように  
段に折りながら  
折り畳む

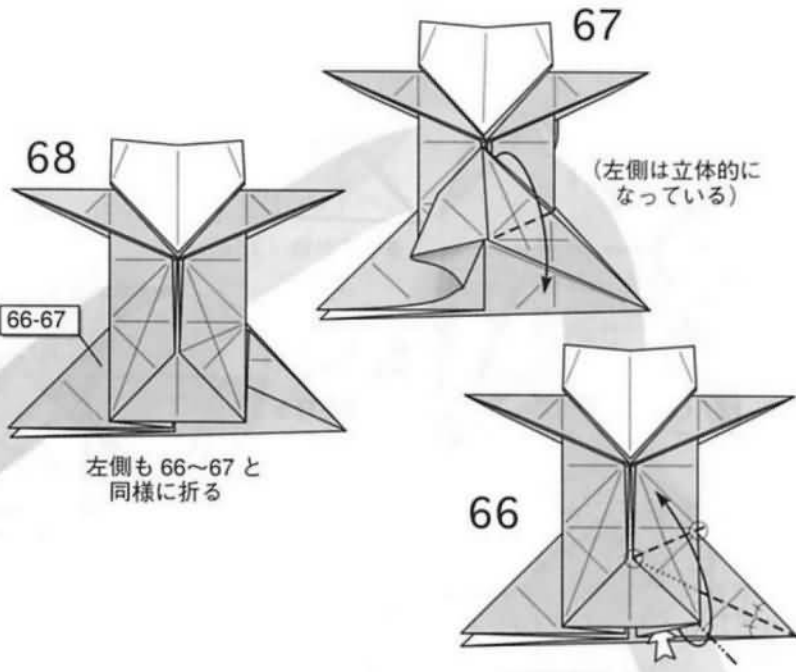

(左側は立体的に  
なっている)

左側も 66~67 と  
同様に折る

66

カドを折り上げ  
持ち上がった紙を  
縁に合わせて  
つぶすように折る

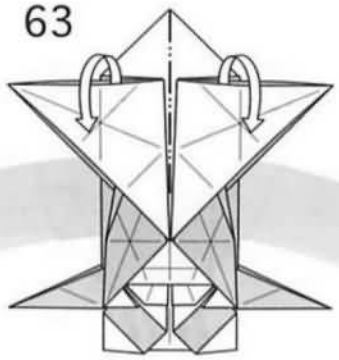

紙の重なりを外して  
内側の紙を引き出す

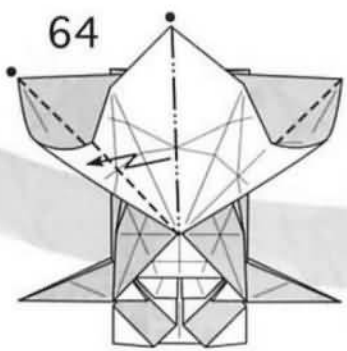

平らに折り畳む

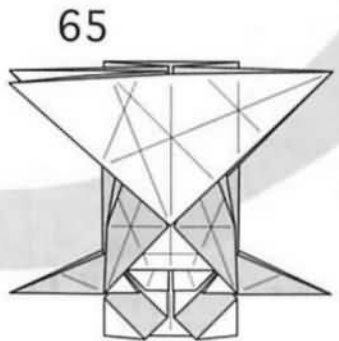

180°

63

64

65

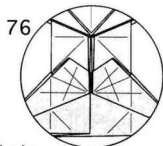
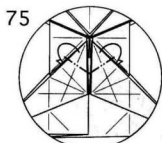

72、73 でつけた  
折り目で慎重に  
向こう側に折り込む



(内側から見たところ)

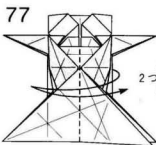

全体を  
2つ折りにして  
戻す

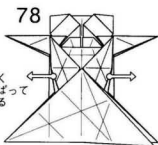

軽く  
引っばって  
広げる

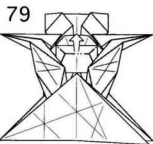

45で押しつぶした  
部分に戻す

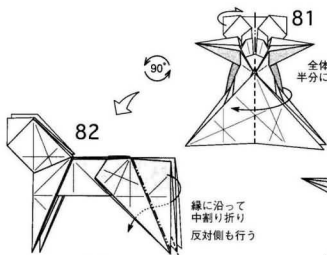

全体を  
半分に折る

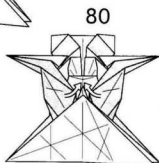

軽くひろげたところを  
くぼみにはめるようにする

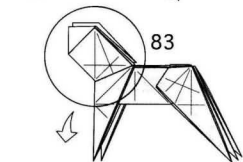

90°

線に沿って  
中割り折り  
反対側も行う

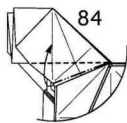

内側から  
紙を引き出す  
反対側も行う

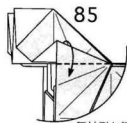

反対側も行う

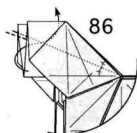

ついている折り筋で  
線に合わせて  
中割り折り

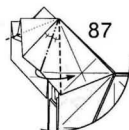

引き寄せ  
るように折る  
反対側も行う



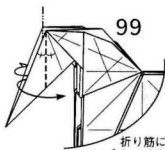

99  
折り筋に線を  
合わせるように  
中割り折り

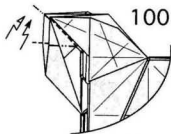

100  
かぶせるように  
斜めに段折り

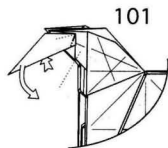

101  
ずらして引き下げる

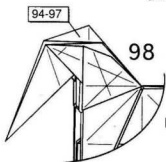

98  
反対側も  
94~97と  
同様に折る

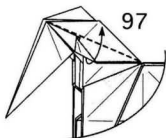

97

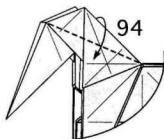

94  
(軽く) 折り下げる

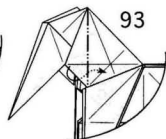

93

前の図の白矢印の隙間に  
(ヒダを止めるように)  
折り込む 反対側も行う

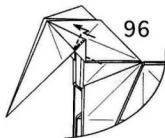

96  
カドをずらすように  
引き寄せ折り



95  
折り筋に  
合わせて折る

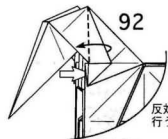

92  
(白矢印は  
次の図を参照)

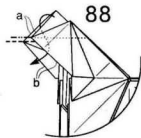

88  
aとbの線を  
合わせるように  
中割り折り

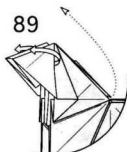

89  
少しひらいて  
重なっている紙を  
はがすようにする

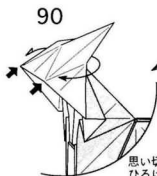

90  
思い切って  
ひろげて  
かぶさっている  
紙をひっくり返す



91  
そのまま  
ついている折り目で  
次の図のように  
まとめる

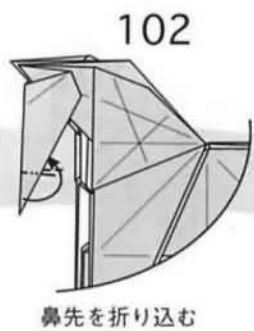

102

鼻先を折り込む



103

顔を上げるように斜めに段折り

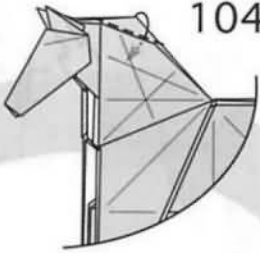

104

外側の縁に合わせて  
どちらかの側に  
折り込む

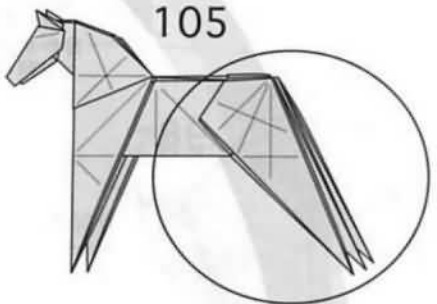

105

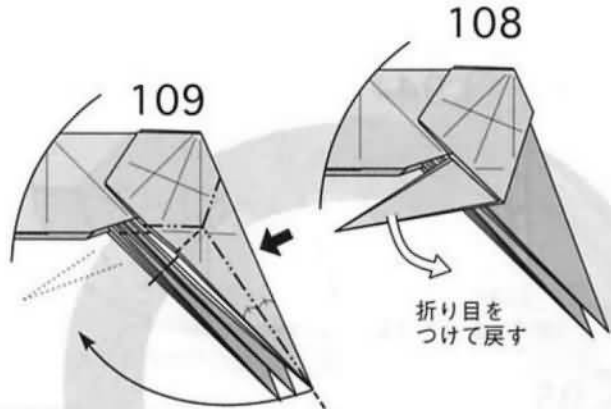

108

折り目をつけて戻す

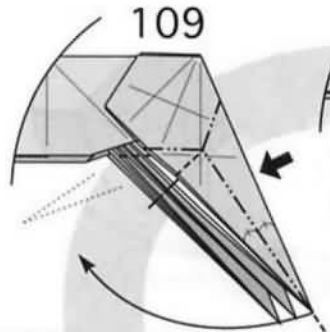

109

つけた折り目を使って  
細くつぶすように折る (dubble rabbit ear)



110

外の1枚だけ  
引き出す

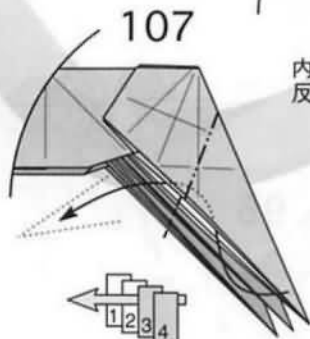

107

内側に折る  
反対側も行う

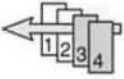

ヒダを2枚ずつに分けて中割り折り



111

次の図の  
位置に  
中割り折り



112

紙の縁と  
折り筋が  
一直線上に  
来るように折る



113

すぐ後ろの  
隙間に折り込む  
(次の図を参照)

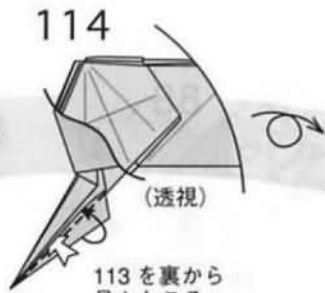

114

(透視)

113を裏から  
見たところ

